



Operating instructions

(Translation of the original operating instructions)

StrongMaster 1 - IFA

StrongMaster 2 - IFA

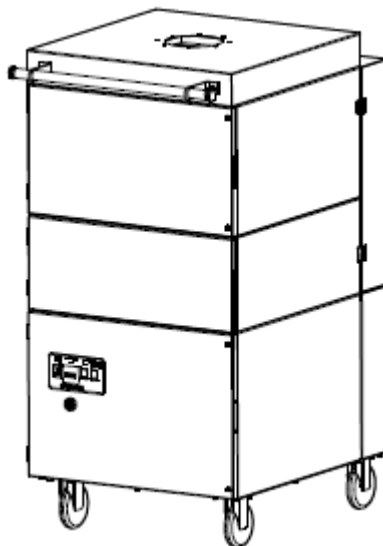



Table of contents

1. General	3
2. Description of the system elements	4
2.1. Illustration of the system elements	4
2.2. Functionality of the system	5
2.3. Intended use	5
2.4. Residual risk	5
3. Safety instructions	6
3.1. Definition of the hazard symbols	6
3.2. General safety instructions	6
4. Storage, transport and installation of the device	7
5. Commissioning	8
5.1. Connecting an extraction element	8
5.2. Electrical connection	9
5.3. Coating of the filter cartridges with cartridge protection	9
6. Operating the system	10
6.1. Explanation of the operating elements	10
7. Maintenance	11
7.1. Reset to maintenance state	12
7.2. Cleaning the filter cartridges	12
7.3. Replacing the filter cartridges	13
7.4. Emptying the dust collecting tank	17
7.5. Coating of new filter cartridges with cartridge protection	18
8. Dismantling / Disposal	19
9. Diagnostics and troubleshooting	19
10. List of spare parts	21
11. Technical data	22
12. EC declaration of conformity	23
13. Training protocol	24
14. Maintenance intervals	25
14.1. Usage-related maintenance	25
14.2. General maintenance	25
14.2.1. Visual inspection of the device	26
14.2.2. Functional test of the device	26
14.2.3. Electrical test of the electrical lines and earthing connections	27

1. General

Congratulations on purchasing the product from TEKA.

Our engineers ensure that our devices reflect the state of the art through continuous development. Nevertheless, misuse or misconduct can endanger your safety. Please observe the following for a successful use of the device:

	<p>Only authorised and instructed personnel can carry out transport, operation, maintenance and repair of the device. The operator must ensure that the operating personnel take note of these instructions.</p> <p>Please read these instructions before operating the device, and observe the safety precautions to avoid injury!</p> <p>Store this manual in a safe place! These instructions are to be regarded as a component of the product!</p> <p>Adhere to all product notes!</p> <p>Modifications or conversions that the operator carries out at the device without the consent of the manufacturer, can lead to new safety hazards or to the loss of warranty claims.</p> <p>Observe the manufacturer's instructions. Contact the manufacturer in case of any uncertainty: Tel: +49 2541-84841-0 E-mail: info@teka.eu</p>
---	---

2. Description of the system elements

2.1. Illustration of the system elements

Installation example:

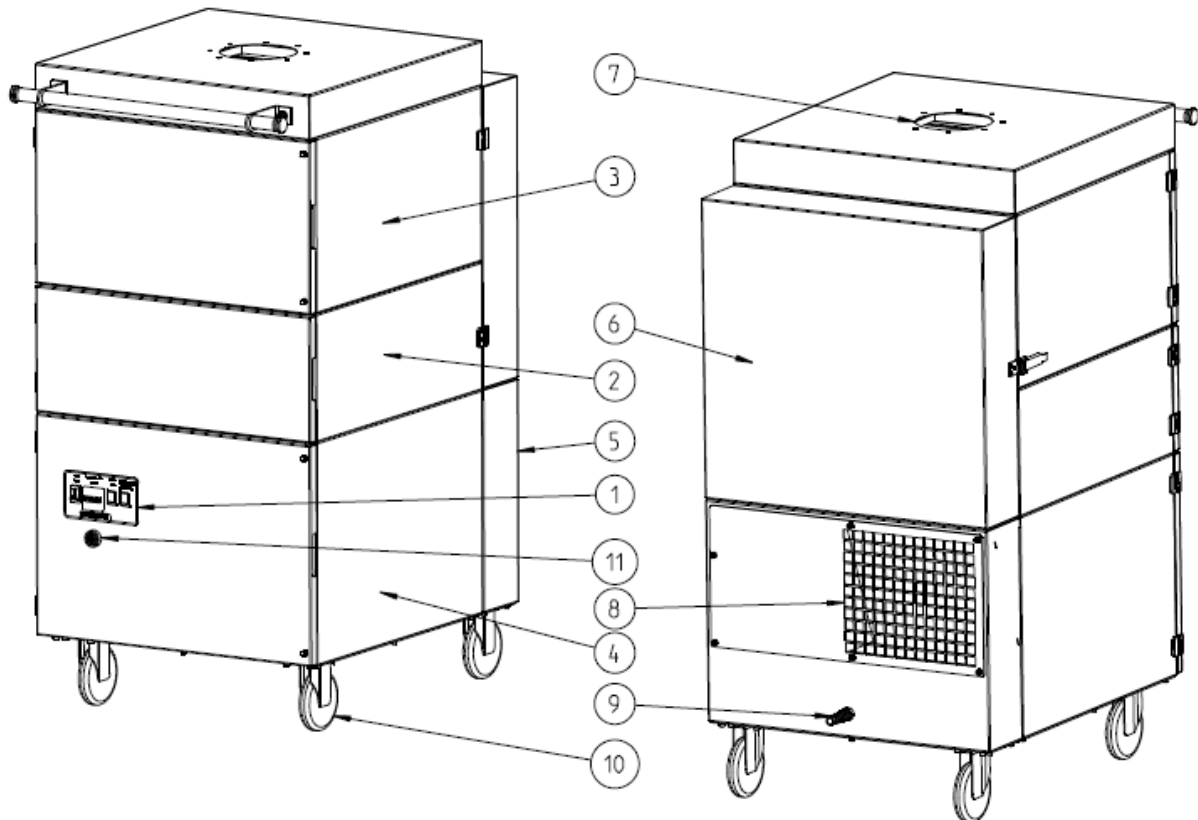

Z.Nr. 13464702

Pos.1	Operating elements	Pos.7	Suction nozzle (StrongMaster 1: 1x, StrongMaster 2: 2x)
Pos.2	Dust collecting housing	Pos.8	Exhaust grille
Pos.3	Filter housing	Pos.9	Mains cable with plug
Pos.4	Fan housing	Pos.10	Swivel castor
Pos.5	Silencing housing	Pos.11	Signal horn
Pos.6	Service door for cleaning the filter cartridges		



Use the supplied Allen key to open and close the service doors. It is located on the handle.

2.2. Functionality of the system

The filter unit serves to suck off and filter polluted air (according to the intended use). The air is purified on the surface of the filter cartridge in the filter section of the unit. The separated dust is collected in a dust collecting tank. An automatic filter monitoring indicates when a cleaning or a replacement of the filters is necessary. The purified air is led back into the working room via an exhaust air grille.

2.3. Intended use

The device is intended for commercial use. If the device is made publicly accessible, it must never be operated unsupervised by authorized personnel, authorized by the operator.

The filter unit is intended for extraction and filtration of dusts and fumes that result from thermal joining and cutting of metals. The filter unit is amongst others suitable for separating welding smokes of unalloyed and alloyed steels, which may also contain CMR substances, as well as of high-alloy chromium-nickel steels and therefore meets the highest welding fume separation category "W3" according to DIN EN ISO 21904-1 / -2.

	WARNING
	Improper use can damage parts and be a danger to life and limb! The device must not be used for the extraction of oil-laden welding fume, explosive dust and gases, hybrid mixtures, glowing or burning substances, gases, water, etc. The device must not be operated in explosive zones.
	Dangers arising from fire. If the sucked medium is combustible fume or dust, the operator must determine beforehand which fire protection measures are to be taken.
	Loss of the "W3" approval and dangers to life and limb when non-original spare parts are used. Only original TEKA spare parts must be used. In case of non-compliance, the system loses its "W3" approval according to DIN EN ISO 21904-1 / -2.

2.4. Residual risk

	CAUTION
	Danger due to possible hazardous materials in the exhaust air flow. Because the unit does not monitor the quality of the air in the exhaust air flow, we recommend that you always guide the exhaust air flow exiting our unit to areas (e.g. to the outside into the open air) in which there is no danger to any living being. To do this, it is necessary to fit a suitable exhaust air line at the filter unit.

3. Safety instructions

3.1. Definition of the hazard symbols

The device is constructed according to the state of the art and the recognised safety regulations. Nevertheless, during use threats to life and limb of the user or other persons may arise. The impairment of the machine or other property are also possible. In these instructions we warn by using corresponding indications.

	WARNING WARNING These instructions are made in case of risks that can lead to <u>injury or death</u> .
---	--

	CAUTION CAUTION These instructions are made in case of risks that can lead to <u>injury</u> .
---	---

	NOTICE NOTICE These instructions are made in case of risks that can lead to <u>material damages</u> .
--	---

	Information notes are no hazard warnings; they call attention to useful information.
---	--

3.2. General safety instructions

	WARNING Dangers arising from improper use / unauthorised operations. The operator must ensure that their authorised personnel are familiar with all the safety indications in this manual in advance. The operator is responsible for ensuring that all work is carried out by authorised and qualified personnel. We therefore recommend using the training protocol on the last page for that purpose (see chapter "Training protocol"). Laymen are allowed to operate the device after having received the necessary instructions. But they are not allowed to carry out any installation, repair or maintenance work. Dangers arising from fire. In case of fire, if possible, switch the unit immediately off or disconnect it from the power supply. Fire extinguishing measures which the operator is obliged to determine beforehand must be initiated immediately.
---	--

	WARNING
<p>Dangers arising from electricity. The operator must ensure that electrical plants and equipment are only built, modified and maintained by a qualified electrician or under the direction and supervision of a qualified electrician. Do not work on components if you are not sure that these are disconnected. If necessary, disconnect the device from the electric power supply and secure it against unauthorized restarting.</p>	

4. Storage, transport and installation of the device

	WARNING
<p>Risk of injury from tilting or unmounted components when stored or transported. The device must be secured against tilting and slipping when it is stored or transported. Do not stand under or next to the floating load. Lift trucks, forklift trucks and transport cranes must have a sufficient minimum load bearing capacity. Pay attention to uneven grounds during the transport. Avoid jerky pushing.</p>	
<p>Dangers arising from tilting or functional impairments at its destination. The unit may only be set up on a suitable surface. The surface must be vibration-free and horizontal. The operator must check the bearing capacity of the surface. As soon as the unit has reached its intended destination, the brakes of the castors must be activated.</p>	

	NOTICE
<p>Damage or functional impairment of the unit due to climatic influences. The unit must be stored in a dry place and protected against moisture during transport. As a matter of principle, the filter unit is not designed to be installed outside.</p>	

5. Commissioning



WARNING

Dangers arising from a defective condition of the unit.

Make sure that the measures described in this chapter are completed before the commissioning of the unit. All doors of the unit must be closed and all necessary connections must be attached before turning the unit on. Do not operate the unit if any components are defective, missing or damaged. Check the orderly condition of the unit before switching it on. The unit must not be operated without a filter element.



NOTICE

Damaged supply lines.

Make sure that the supply lines are protected against damage by forklift trucks and similar events. Protect all supply lines from heat, moisture, oil and sharp edges.

5.1. Connecting an extraction element

For extracting the contaminated air - according to the intended use - the provided extraction element (e.g. suction arm, suction hose, ...) must be connected at the suction nozzle (see chapter 2.1).



The assembly of a suction arm is described in the separate operating manual.

When using a detection element with extraction hood, the extraction hood must track the welding seam, possibly taking advantage of the thermally induced welding fume movements.

CAUTION However, it is important to ensure that connections between the workpiece and the extractor hood (and generally between the workpiece and filter device) are avoided, so that, if necessary, the welding current cannot flow back through the protective conductor of the filter device to the welding machine.

5.2. Electrical connection



NOTICE

Electric malfunction possible in cause of an incorrect power supply.

Pay attention to the admissible supply voltage. Please observe the specifications on the type plate.

- Reconnect the mains cable (see chapter 2.1) to the power supply.
- Make sure that the fan impeller rotates in the required direction when switching it on for the first time. If not, it results in a low extraction capacity. For visual inspection, there is a sticker attached to the bottom of the dust collecting housing (see chapter 2.1). For the connection points of 400V and 500V the rotating field might be incorrectly set and must be changed, if necessary. Briefly switch the device on and off. The fan slowly starts running and the rotation direction can be compared to the sticker.



CAUTION When the fan rotates in the wrong direction, the extraction capacity is reduced.

5.3. Coating of the filter cartridges with cartridge protection

For a longer service life of the filter cartridges we recommend to coat them with a cartridge protection. The coating can only be carried out during the commissioning at the operation site. When the operator orders and installs new filter cartridges, we recommend to also coat them before the commissioning.







Please read and refer to "Coating of new filter cartridges with cartridge protection" in the chapter "Maintenance". There you can also find a description of the operating method of the cartridge protection.

6. Operating the system

6.1. Explanation of the operating elements

Operating elements for the device control		
Representation	Designation	Description / function
	ON-OFF-switch	By means of this switch, the device is switched on and off. i When the device is switched off, it is not disconnected from the power supply.

Operating elements for status and error messages		
Representation	Designation	Description / function
	Signal lamp "red"	Flashing up means that the air-flow rate of the device is not sufficient anymore. Filter elements must be cleaned or replaced. When using extraction elements with a suction hood, it is possible that the throttle valve(s) in the suction hood are closed. In this case open the throttle valves.
	Signal horn	Honking signals that the air-flow rate of the device is not sufficient anymore. Filter elements must be cleaned or replaced. When using extraction elements with a suction hood, it is possible that the throttle valve(s) in the suction hood are closed. In this case open the throttle valves.
	Indicator lamp "green"	Flashing up means that the device is in operation.
	Operating hour counter	The number of operation hours during which the device was in operation is shown.

7. Maintenance

In accordance with national regulations, the operator is obliged to carry out repeat and functional tests. Unless otherwise specified by national regulations, we recommend regular visual inspections and functional tests of the device as described in the chapter "Maintenance intervals".



You find the chapter "Maintenance intervals" at the end of the document. The general maintenance (visual inspection, etc.) is also explained there.

In the chapter "Maintenance intervals" there is information on the maintenance intervals of the filter elements. But these are only recommendations. Depending on the application (multi-shift operation, dust generation, ...) it may be necessary for the operator to change the maintenance intervals.

In this chapter the maintenance work which is caused by wear caused during operation is described.



WARNING

Work on the open system entails the risk of electrical shock or accidental restart the system. Both pose a danger to life and limb.

When cleaning and servicing equipment during the replacement of parts or when changing to another function, set the device to maintenance condition first (see chapter "Reset to maintenance state").

A recommissioning of the device must only occur if it is ensured that the device is functionally equivalent to the original state.

Dangers to life and limb when non-original spare parts are used

Only original TEKA spare parts must be used.



CAUTION

Hazards to the respiratory tracts are possible due to contact with contaminated filter elements.

All maintenance work must only be carried out in well-ventilated rooms and while wearing an appropriate respiratory mask! We recommend: respiratory protection half mask DIN EN 141/143 protection level P3. For all maintenance work ensure a cautious handling of filter elements and components in order to avoid whirling up dust.



The operator is obliged to store and dispose of the collected dust in accordance with national or regional regulations. For all maintenance or cleaning work please refer to the applying environmental regulations. Pollutants and filter elements must be disposed of or stored according to the regulations as well. If you have any doubts, we recommend contacting a disposal contractor in your area.

7.1. Reset to maintenance state

- Switch off the unit. Unplug the mains plug. Secure the unit against unauthorized restarting during maintenance.
- After completion of all maintenance work the unit can be reconnected to the power supply.

7.2. Cleaning the filter cartridges

The filter cartridges are reusable filters and can be cleaned. The cleaning of the filter cartridges is carried out manually.

The degree of pollution of the filter cartridges is electronically monitored. When the maximal admissible differential pressure value is reached, the device triggers “filter alarm” (see chapter “description of the control elements”). Now a cleaning is necessary. If despite of the cleaning of the filter cartridge the alarm value is not undercut anymore, the filter cartridge must be replaced. (see chapter: “Replacing the filter cartridges”).

- Close all front service doors in case they are open. When using a suction arm as an extraction element, close the throttle valve at their suction hood.

CAUTION In case the service doors are open, dust can escape during the cleaning.

- Open the rear service door of the filter housing.



- Use a compressed air pistol for the cleaning. These must be connected to the external compressed air supply of the operator.

NOTICE The compressed air must be dry and oil-free. The operating pressure must be between 3 and 4 bars.

- Hold the compressed air pistol into the interior of the filter cartridge. Blow steadily with the compressed air pistol into the crinkles of the filter cartridge. Clean it for at least 5 minutes.







- Close the rear service door of the filter housing.
- When using a suction arm as an extraction element, open the throttle valve at their suction hood.

7.3. Replacing the filter cartridges





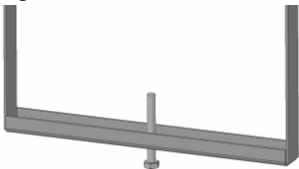
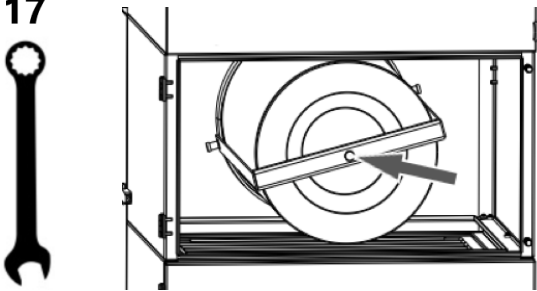

Replacing the filter cartridges becomes necessary when the filter cartridges are saturated with dirt in a manner that despite of the cleaning the filter alarm is triggered again at very short intervals or permanently. (The filter alarm is described in chapter "Cleaning the filter cartridges".)

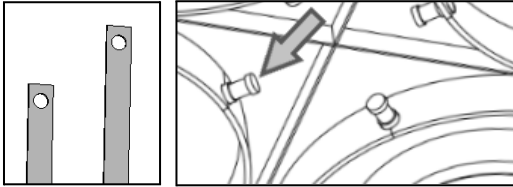
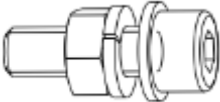
	CAUTION
<p>Whirling up dust is possible due to the polluted filter cartridges. The filter cartridges must be cleaned before being replaced. Proceed as described in chapter "cleaning of the filter cartridges". After cleaning the filter cartridges wait about 5 minutes before opening the service door of the filter housing.</p>	

	<p>We recommend to coat new filter cartridges with cartridge protection before the first commissioning. Refer to the chapter "Coating of new filter cartridges with cartridge protection".</p>
---	--

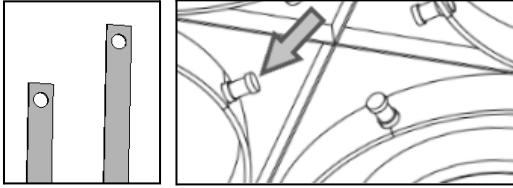
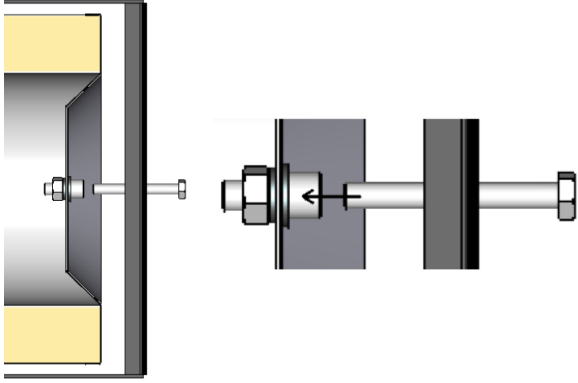
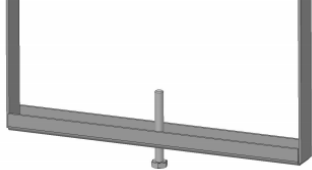
<ul style="list-style-type: none"> • We recommend that two people work together to replace the filter cartridges. • We recommend spreading out a protective film in order to keep the area around the unit clean. 	
<ul style="list-style-type: none"> • CAUTION The filter cartridges may only be replaced in well-ventilated rooms and while wearing an appropriate respiratory mask! We recommend: Respiratory protection half mask DIN EN 141/143 protection level P3. • We also recommend using additional protective clothing such as gloves, disposable overalls and protective eyewear. 	
<ul style="list-style-type: none"> • Make available an original disposal bag already before changing the filter cartridges (see list of spare parts). We recommend to stock up disposal bags in good time. 	
<ul style="list-style-type: none"> • Open the filter housing's service door. 	<p>8</p> 
<ul style="list-style-type: none"> • Loosen the fixing screw. This is located at the bottom of the cartridge holder. Loosen the fixing screw but do not unscrew it from the cartridge holder. It is important that the cartridge holder is still held loosely. 	<p>17</p> 

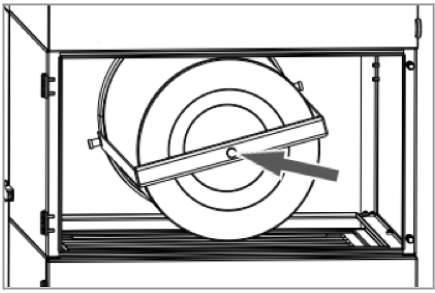
<ul style="list-style-type: none"> • Pull the disposal bag over the cartridge holder and filter cartridge. 	
<ul style="list-style-type: none"> • Unhook the cartridge holder from the cartridge guides.  <ul style="list-style-type: none"> • Remove the cartridge holder with the filter cartridge and the disposal bag from the filter housing. 	
<ul style="list-style-type: none"> • Briefly lift the filter cartridge in order to release it from the cartridge holder. • Next, pull the cartridge holder with little dust on it out of the disposal bag and past the filter cartridge. 	
<ul style="list-style-type: none"> • Undo the screw connection that is fixed at the base of the filter cartridge. This screw connection must be attached at the base of the new filter cartridge. When this is done, the head of the screw must face outwards. 	

<ul style="list-style-type: none"> Seal the disposal bag (e.g. with cable ties). <div data-bbox="260 387 772 524" style="border: 1px solid black; padding: 5px;"> <p>i The operator is obliged to store and dispose of contaminated filter cartridges in accordance with national or regional regulations.</p> </div>	 
<ul style="list-style-type: none"> First of all, remove <u>all</u> the filter cartridges as described in the steps above. Only then should you start to install the new filter cartridges. <p>NOTICE Only use TEKA replacement filters. Otherwise the correct functioning of the unit is not guaranteed, and there is a danger to life and limb.</p>	
<ul style="list-style-type: none"> Insert the new filter cartridge in the cartridge holder. When you do this, the fixing screw must engage in the head of the screw that is attached at the base of the filter cartridge. Insert the cartridge holder with the new filter cartridge in two of the cartridge guides. <div data-bbox="264 1205 778 1391">  </div>	
<ul style="list-style-type: none"> Screw the fixing screw tight. <p>NOTICE If the fixing screw is not properly tightened then the seal at the top of the filter cartridge may not be pressed on sufficiently.</p> 	<p>17</p>  
<ul style="list-style-type: none"> Close the service door. 	<p>8</p> 

7.4. Emptying the dust collecting tank

The dust collection container must be cleaned after a certain number of operating hours. This range depends on the amount of dust. The filling level has to be proofed at least once a week.



CAUTION

Whirling up dust is possible due to the polluted filter cartridges!

The filter cartridges must be cleaned before emptying the dust collecting tank. The proceeding of the cleaning is described in the chapter "Cleaning of filter cartridges". After cleaning the filter cartridges wait about 5 minutes before opening the service door.



Make available an original dust collection bag already before emptying the dust collecting tank (see spare parts list). We recommend to stock up dust collection bags in good time.

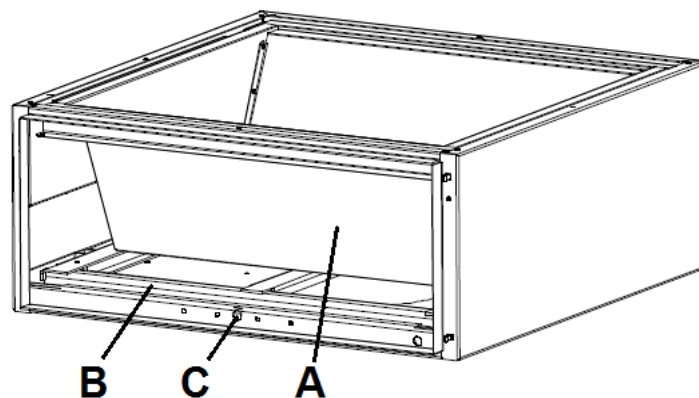



- Open the service door of the dust collecting housing (see chapter 2.1).
- Lower the lifting device (B) by turning the clamping screw (C).
- Carefully pull the dust collecting tank (A) out of the housing.
- Close the dust collection bag (e.g. with a cable fastener).
- Remove the dust collection bag and store or dispose of it according to the regulations.
- Place a new dust collection bag in the dust collection container so that the bag is put over the edge of the dust collection container.
- Push the dust collecting tank back into the dust collecting housing.
- Elevate the lifting device by turning the clamping screw so that the dust collection container is pressed tightly against the above housing.
- Close the service door.

7.5. Coating of new filter cartridges with cartridge protection

Before the first commissioning new filter cartridges can be coated with cartridge protection. The cartridge protection assists against a "caking" of extracted particles on the filter surface and thus prolongs the life of the new filter cartridge.

Unlike with other maintenance work, this step must be carried out with the system switched on and operating. This is necessary to allow the cartridge protection to disperse on the surface of the filter cartridges through suction.

	CAUTION	
	<p>On contact the cartridge protection can be hazardous to the respiratory tract and cause skin irritation or eye irritation. Only use TEKA cartridge protection. Non-compliance can result in dangers to life and limb.</p> <p>Observe the listed manufacturer instructions provided:</p> <p><i>Handling:</i> Avoid the formation of dust!</p> <p><i>Storage:</i> Seal the container tightly before storage!</p> <p><i>Respiratory protect:</i> Dust mask without protection level!</p> <p><i>Hand protection:</i> Protective gloves in cloth, rubber or leather!</p> <p><i>Eye protection:</i> Safety glasses with side shields!</p> <p><i>Body protection:</i> Anti-static work shoes!</p>	

- Provide sufficient cartridge protection. We recommend using **10 grams** for each **square metre** of the **filter surface**. The cartridge protection is available at TEKA (see list of spare parts).
- Choose the capture point in the suction pipe that is the closest to the filter cartridges. E.g. an inspection flap can be used as a capture point.

NOTICE Electrical short-circuit due to LED lighting possible. If the extraction cowl of a suction arm is chosen as an extraction point then this extraction cowl may only be used if it is not equipped with LED lighting. Otherwise, the cartridge protection must not be extracted via the extraction cowl but, for example, via the hose of the suction arm by disconnecting this from the extraction cowl for this period.

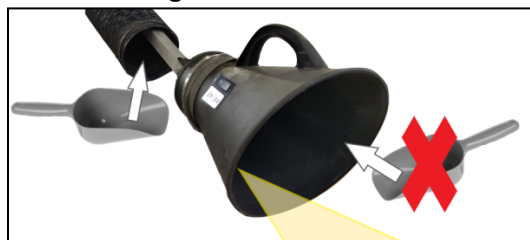



- Switch the device on.
- Let the cartridge protection bit by bit be sucked in via the capture point.

8. Dismantling / Disposal

Only authorised personnel may disassemble the machine.

	WARNING
	<p>Dangers arising from electricity. Before the dismantling of the machine it has to be disconnected from the power supply and all supply lines.</p>

	CAUTION
	<p>Whirling up dust is possible due to the deposited dust. During all work a suitable respiratory protection and protective clothing have to be worn.</p>

	The operator is obliged to store and dispose of the collected dust in accordance with national or regional regulations.
---	---

9. Diagnostics and troubleshooting

A list of possible system errors is provided in the table.

	Faults indicated by control elements are explained in the chapter "Description of the control elements".
---	--

A recommissioning of the device must only occur if it is ensured that the system is functionally equivalent to the original state. Repairs may only be carried out by TEKA personnel or, after consultation with TEKA GmbH, by the personnel authorised by the operator.

Adhere to the instructions in the chapter "Safety instructions" and "Maintenance" when carrying out any repairs. If in doubt, contact our TEKA service department:

Tel: +49 2541-84841-0
E-mail: info@teka.eu

Fault	Cause	Removal
System does not start.	Plug power supply is missing or incorrectly inserted.	Plug connector check power supply / plug in correctly.
	No power at outlet.	Check the mains, remove error if possible.
Dust at the dust collecting tank.	There is too much dust in the dust collection container.	Empty the dust collecting tank.
	The lifting device has not been lift up.	Screw up the lifting device.
	The seal of the dust collecting tank is damaged.	The seal must be replaced.

Dust at the service door of the filter housing.	The door is not correctly closed.	Close the door.
	The seal between the service door and filter housing is damaged.	The seal must be replaced.
	Escape of dust at the hinge.	The hinge must be reoriented or replaced.
Suction power too low (smoke hardly extracted).	Filter element is saturated.	Replace the filter package, dispose of old filter properly!
	Damage at the extraction elements.	Replace the extraction elements.
	The motor rotates in the wrong direction.	The rotating field of mains connection point must be changed.
	Suction line contracted.	Check and fix.
	Exhaust line contracted.	Check and fix.
	Maybe throttle valves are used in the suction line.	Adjust throttle valves.
The system is very noisy.	The motor rotates in the wrong direction.	The rotating field of mains connection point must be changed.
	The unit is untight.	Check and fix.

10. List of spare parts

Please include the machine number with every order or inquiry.

	WARNING
<p>Dangers to life and limb when non-original spare parts are used. Only original TEKA spare parts must be used.</p>	

Filter element	Article no.
Filter cartridge, Type "BIA-M", 10,0m ² (Ø327 x 600 mm) <i>(StrongMaster 1: 1 piece of these filter elements are required for the device)</i> <i>(StrongMaster 2: 2 pieces of these filter elements are required for the device)</i>	6160600110008
Disposal elements	Article no.
PE-bag for the disposal of filter cartridges (4 pieces)	10030251702
PE-bag for inserting into the dust collecting tank (10 pieces)	10030250
Cartridge protection	Article no.
"NANNOX P50" for filter cartridges, 400g (in a bucket)	68130000400
"NANNOX P50" for filter cartridges, 100g (in a bucket)	68130000100

11. Technical data

Version		StrongMaster 1 IFA	StrongMaster 2 IFA
Supply voltage	V	230 / 400 / 500	
Frequency	Hz	50	
Type of current	Ph	1 / 3 / 3	
engine power	kW	1,1	2,2
Air flow volume max.	m³/h	1860	2500
Air flow volume (possible operation point)	m³/h	1210	2220
Air flow volume min.	m³/h	700	1160
Negative pressure max.	Pa	2900	2800
Protection class		IP54	
Welding fume extraction class (according to EN ISO 21904-1 / -2)		W3	
Width	mm	665	665
Depth	mm	820	820
Height	mm	1365	1770
Weight	kg	165	180
Sound pressure level	dB(A)	72	74
Allowed ambient temperature	°C	+5 to +35 (<i>during operations</i>) -10 to +40 (<i>during transport and storage</i>)	
Max. temperature of polluted air at the capture point	°C	+50	
Allowed max. humidity	%	70 (non-condensing)	

12. EC declaration of conformity

according to the Machinery Directive 2006/42/EG, Annex II, 1 A

TEKA Absaug- und Entsorgungstechnologie GmbH
Millenkamp 9, D-48653 Coesfeld

Tel.: +49 2541-84841-0

E-Mail: info@teka.eu

Internet: www.teka.eu

Designation of the device: StrongMaster 1 - IFA / StrongMaster 2 - IFA

We hereby declare under our sole responsibility that the product mentioned above, from the serial number A28000010011001 resp. P75300010011001 on, conforms to the following directives:

Machinery Directive: 2006/42/EG

Electromagnetic Compatibility: 2014/30/EC

RoHS directive: 2011/65/EU

This declaration will become void if the device is exposed to modifications that are not approved by the manufacturer in written form.

Authorized representative for the technical documentation:

TEKA Absaug- und Entsorgungstechnologie GmbH, Millenkamp 9, D-48653 Coesfeld

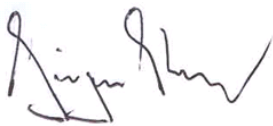

(Jürgen Kemper, managing director)

Coesfeld, 3rd January 2026



13. Training protocol

Designation of the device: StrongMaster 1 - IFA / StrongMaster 2 - IFA

(This form can be used by the operator to document the training of the employees. Training should be performed by authorized personnel only. Refer to the instructions in Chapter "Safety Instructions")

By his signature, the employee confirms that he has been instructed regarding the following items:

Instruction	completed
Description of the device	
Operation and application of the device	
Explanation of the safety instructions	
Behavior in case of fire	
Explanation of the operation elements	
Change and dedusting of the filter elements	
Emptying of the dust collecting tank	
Appropriate disposal	
Maintenance works / Maintenance intervals	

Name of the employee (legible)	Signature

Introduction through (legible):	
Signature:	

14. Maintenance intervals

14.1. Usage-related maintenance

The described maintenances become necessary through the demands of the system operations. The maintenance intervals are recommendations. Depending on the application (multi-shift operation, dust generation, ...) it may make sense for the operator to change the intervals of maintenance, replacing and cleaning.

Maintenance work must always be documented by means of a protocol.

The approach of the maintenance measures is described in chapter "Maintenance".

Maintenance work	Chapter	Maintenance interval	
		recommended by TEKA	determined by the operator
Cleaning the filter cartridges	7.2	The cleaning of the filter cartridges must be carried out at the latest when the device signals a filter alarm.	
Replacing the filter cartridges	7.3	The saturation of the filter cartridges is automatically monitored by the filter unit and thus is not subject to a maintenance interval. If the filter unit triggers an alarm, a cleaning of the filter cartridges is necessary. If the device is still signalling a filter alarm, it is necessary to replace the filter cartridges.	
Emptying the dust collecting tank (or check of fill level)	7.4	weekly	

14.2. General maintenance

The described maintenances are independent from the demands of the system operations.

The operator is obliged to carry out repeated inspections and functional tests according to national regulations. If not otherwise covered by national regulations, the described maintenance intervals must be respected.

Maintenance work must always be documented by means of a protocol.

Maintenance work	Chapter	Maintenance interval
Visual inspection of the device	14.2.1	weekly
Functional test of the device	14.2.2	monthly
Electrical test of the electrical lines and earthing connections	14.2.3	annually

14.2.1. Visual inspection of the device

Visual inspection: Observation that there are no visible safety-related defects.

	WARNING Danger arising from the ready to operate condition of the device. Follow the procedure as described in the chapter "Set to maintenance state".
---	--

The following steps must be carried out in the course of the visual inspection:

- Check if all required pipeline elements, cable connections and hoses are connected to the filter unit
- Check all electrical earthing connections and cables for visible damages.
- Ensure that all parts are firmly connected.
- Check all connection points of the filter unit for escaping dust.
- Check all metal parts for corrosion or damages / changes of the coating.
- Check the inner filter area and the filter housing.
- Visual inspection of the control and operating elements as well as the outside running cables for damages.
- Check the dust collecting tank for tightness, check the sealing rubber of the tank.

14.2.2. Functional test of the device

	NOTICE Possible material damage due to faulty condition of the unit. Carry out a visual inspection before the functional test of the device as described in the previous chapters. The work as described in the chapter "Commissioning" must be finished.
---	--

The following steps must be carried out in the course of the functional test:

- Switch on the device.
- Pay attention to failures or error messages of the control unit. Also refer the separated operating manual of the control unit.
- Pay attention to extraneous noises or vibrations during the device's operation.
- A functional test should always be carried out with a connected / producing machine tool. Check if the collection of the fume or dust is sufficient. (Visual inspection).

14.2.3. Electrical test of the electrical lines and earthing connections

	WARNING
Danger arising from electricity. The operator is responsible for ensuring that all work on electric components is carried out by authorised and qualified personnel.	

The device is subject to regular electrical checks by the operator of the device, and are subject to national standards of the different countries.

The here recommended maintenance interval complies with the in Germany applying "Regulation 3 of the German Social Accident Insurance - Electrical plants and equipment" (formerly known as BGV-A3).

The check must only be carried out by a qualified electrician or a person trained in electrics using suitable measuring and test devices. The scope of testing and the methods must be in line with the respective national standard. All contacts in the control cabinet must be checked for tight fit, and must be readjusted if necessary.